



Reduzierung

RCU

- 1
- 2
- 3
- 4
- 5
- 6
- 7
- 8
- 9
- 10
- 11
- 12
- 13
- 14
- 15
- 16
- 17
- 18



Beschreibung

Gepresste, konzentrische Reduzierung

Druckverlust, siehe Diagramm auf Seite 73.

Dimensionen

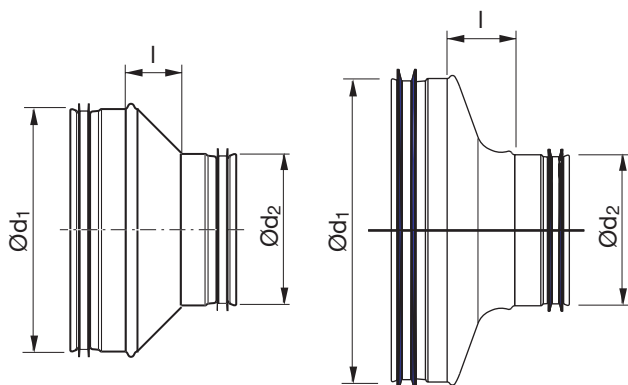

Bestellbeispiel

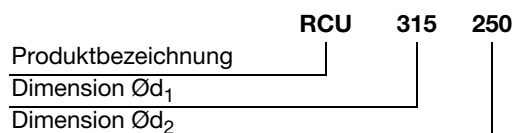

Dimensionen

Ød ₁ nom	Ød ₂ nom	l mm	m kg
80	63	18	0,12
100	63	30	0,17
100 *	80	26	0,18
125 *	80	36	0,16
125 *	100	27	0,21
150	100	36	0,17
150 *	125	31	0,15
160	80	55	0,31
160 *	100	46	0,17
160 *	125	35	0,22
160	150	22	0,26
180	100	55	0,24
180	125	40	0,37
180	150	27	0,29
180	160	20	0,26
200 *	100	46	0,22
200 *	125	55	0,30
200	150	37	0,37
200 *	160	39	0,29
200	180	26	0,35
224	150	48	0,53
224	160	44	0,53
224	180	34	0,48
224	200	24	0,45
250	125	70	0,62
250	150	62	0,60
250 *	160	60	0,46
250	180	47	0,59
250 *	200	42	0,46
250	224	29	0,57
300 *	200	59	0,64
300	250	34	0,71
315	160	91	0,86
315 *	200	74	0,72
315 *	250	50	0,65
355	250	69	1,08
355	315	33	0,99
400	200	118	1,37
400	250	94	1,38
400	315	54	1,29
500 **	250	128	2,30
500	315	95	1,90
500	400	68	1,76
630 **	315	160	3,37
630 **	400	118	3,17
630 **	500	68	2,89

* Strömungsgünstige Ausführung

** Handgebaut



Reduzierungen

RCU, RCFU

Technische Daten

1 Dimensionsverkleinerung

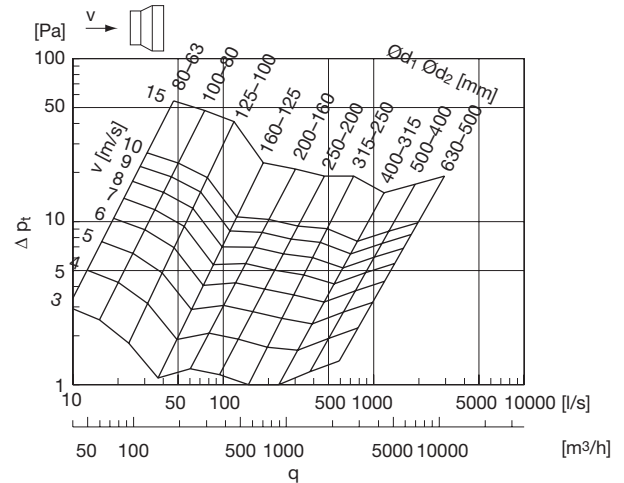
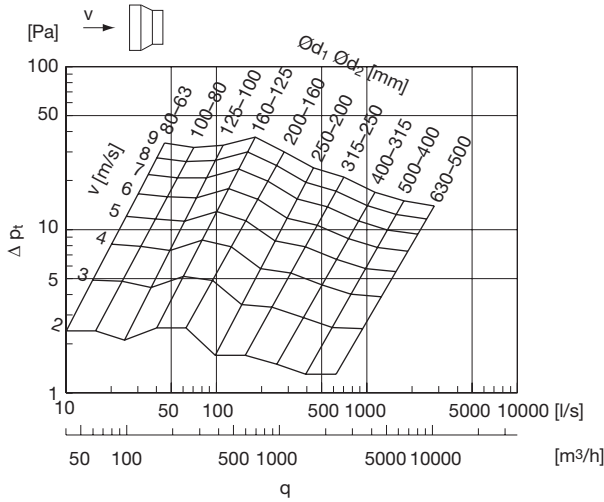

2 Dimensionsverkleinerungen

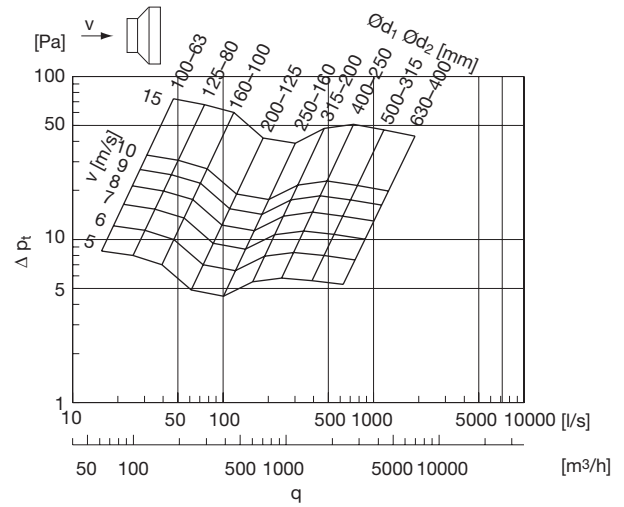
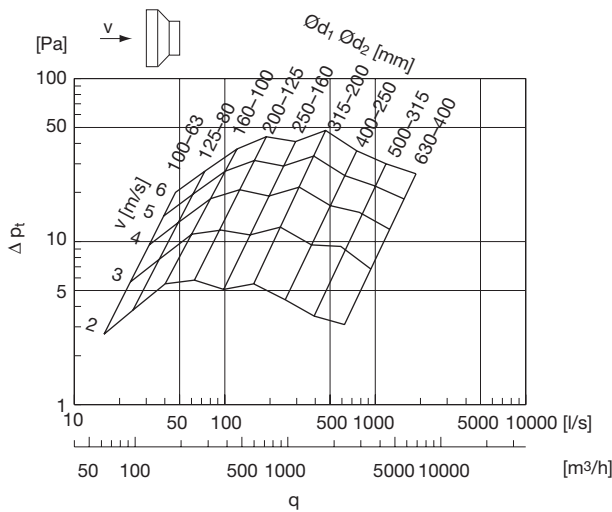

3 Dimensionsverkleinerungen

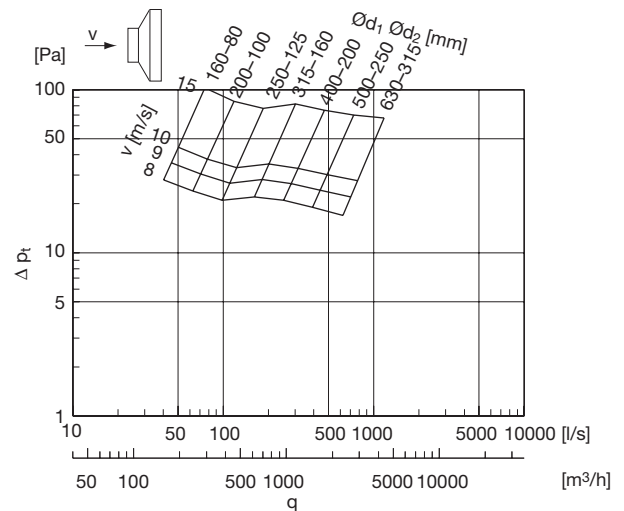
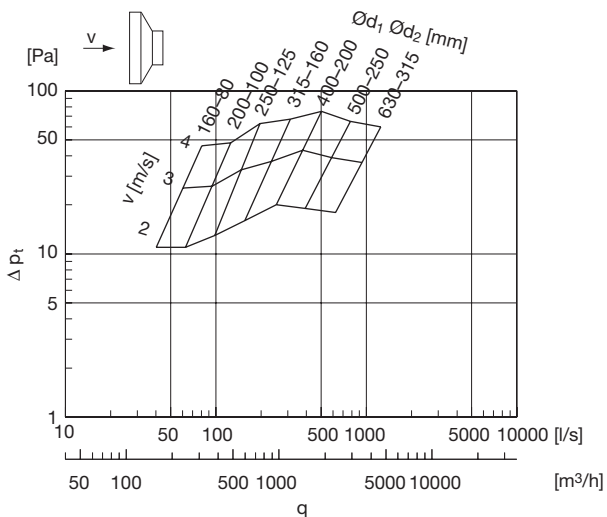

- 1
- 2
- 3
- 4
- 5
- 6
- 7
- 8
- 9
- 10
- 11
- 12
- 13
- 14
- 15
- 16
- 17
- 18